

# ROMAN EURO GRANDE

www.exprocrete.com

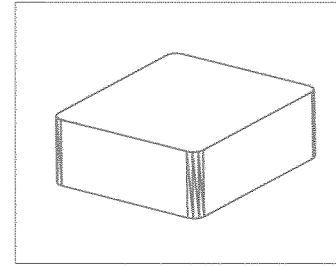
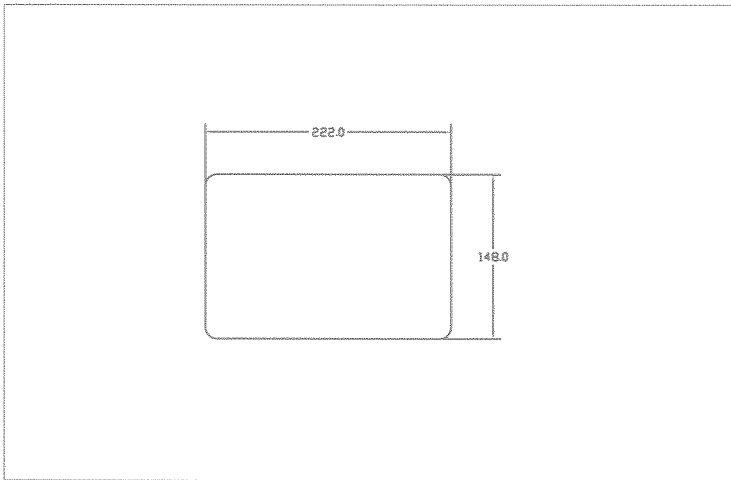

		STONE DIMENSIONS	STONE AREA		STONES/PALLET	AREA/PALLET	PALLET WEIGHT
<b>A STONE</b>	~METRIC~	175x150x60mm	0.027 sq m/Stone	37.9 Stones/sq. m	420	11 sq. m/pallet	1518 kg/pallet
	~IMPERIAL~	7x6x2.38"	0.29 sq. ft./Stone	3.52 Stones/sq. ft.	420	119 sq. ft./pallet	3287 lbs/pallet
<b>B STONE</b>	~METRIC~	150x150x60mm	.023 sq m/Stone	45.7 Stones/sq. m	480	10.5 sq. m/pallet	1414 kg/pallet
	~IMPERIAL~	6x6x2.38"	0.24 sq. ft./Stone	4.25 Stones/sq. ft.	480	113 sq. ft./pallet	3110 lbs/pallet
<b>GRANDE</b>	~METRIC~	222x150x60mm	.03 sq m/Stone	37.0 Stones/sq. m	300	10.8 sq. m/pallet	1325 kg/pallet
	~IMPERIAL~	9x6x2.38"	0.36 sq. ft./Stone	2.78 Stones/sq. ft.	300	116 sq. ft./pallet	2920 lbs/pallet

## SAMPLE PATTERNS

\*Note: Patterns also include Roman Euro 'A' and 'B' Stones. All Quantities Approximate.

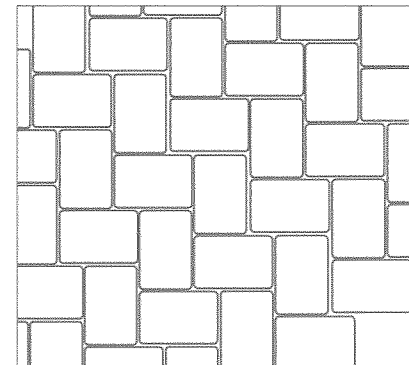
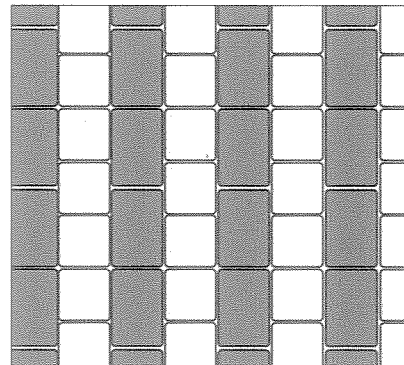
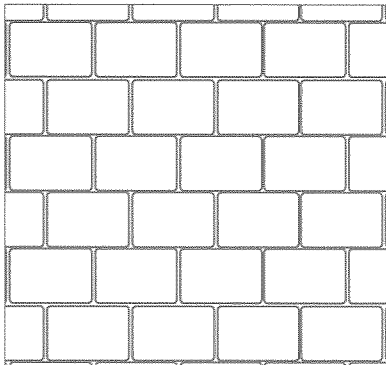

Stones per 100sqft. - 144 Grande  
213 Roman 'B'

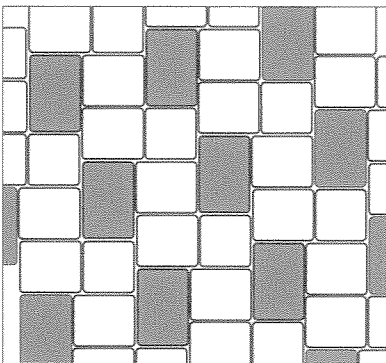

Stones per 100sqft. - 84 Grande  
150 Roman 'A'  
75 Roman 'B'

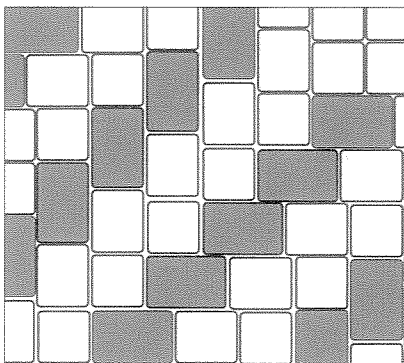

Stones per 100sqft. - 105 Grande  
105 Roman 'A'  
112 Roman 'B'

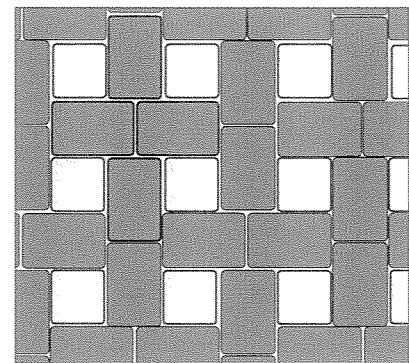

Stones per 100sqft. - 195 Grande  
115 Roman 'B'